

**fluimac**<sup>®</sup>  
p u m p   s o l u t i o n

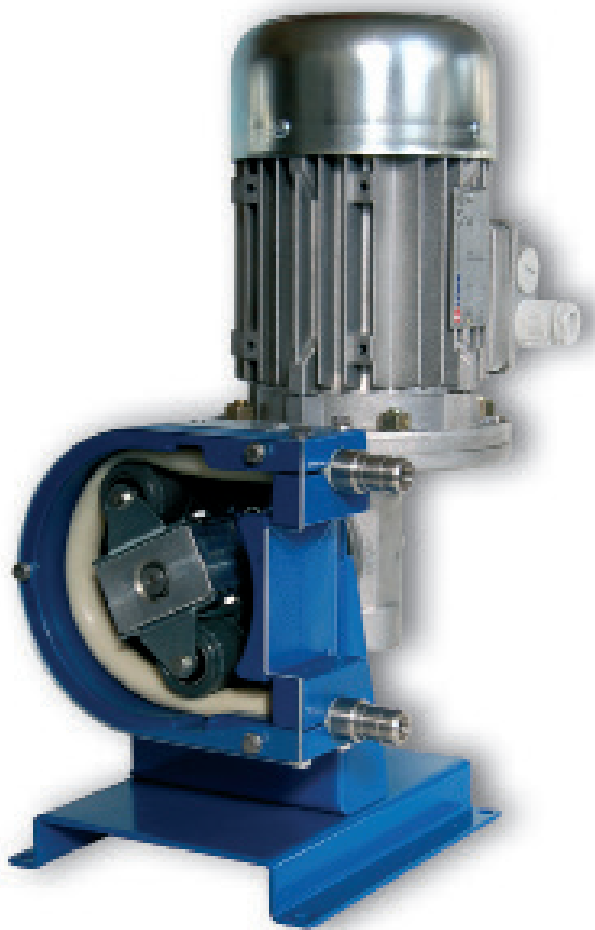

---

**HELIOS**  
PERISTALTIC PUMPS

Made in  
Italy

[www.fluimac.com](http://www.fluimac.com)



# HELIOS AS

**Peristaltic dosing pumps - Low Pressure**

**Capacity up to about 2800 l/h - delivery head up to 4 bar**

**Viscosity up to 15000 cps - Achievable suction up to 6 mts**

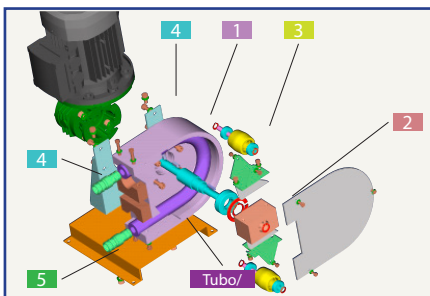

### Element

- 1** Pump casing
- 2** Rotor
- 3** Rollers
- 4** Base
- 5** Hose Connector

### Material

- aluminium alloy
- aluminium alloy
- PVC
- aluminium alloy
- Iron
- AISI 304

### Special couplings:

- Hose Connector in AISI 316, PVC, PTFE
- DIN
- TRI-CLAMPS
- ANSI, ISO, UNI, FLANGES

### TECHNICAL FEATURES

- Accurate and repeatable dosing and metering
- Long life and greater reliability
- Self-priming
- Continuous dry running
- Lowest cost of ownership
- Quick and easy maintenance

### AVAILABLE HOSES MATERIALS

- NR
- NBR
- Norprene ®
- Silicone
- EPDM
- Pharmed ®
- Tygon (AS25)
- Hypalon (AS25)



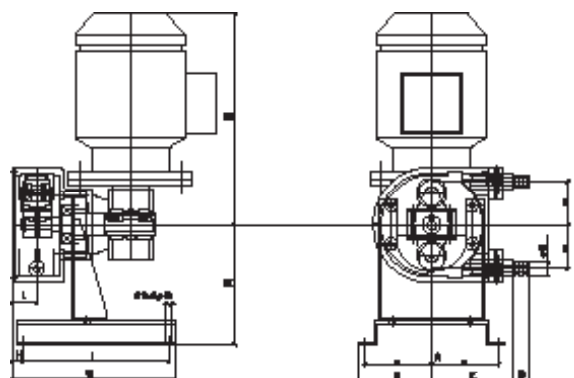

## OVERALL DIMENSIONS

TYPE	A	B	C	D	E	F	G	H	I	L	M	N	øO	Kg.
<b>AS 10 FX</b>	172	92	92	20	15	104	185	12	166	28	137	245	7	9
<b>AS 15 FX</b>	172	92	110	20	20	127	183	12	166	30	137	245	7	10
<b>AS 20 FX</b>	210	112	142	35	25	175	248	18	220	40	184	260	7	18
<b>AS 25 FX</b>	250	146	210	45	32	254	386	81	290	52	228	370	11	40

## TECHNICAL CHARACTERISTICS

TYPE	Q ( L/H)	A	P	RPM	I	KW	di	Qu	Nm
<b>AS 10 FX</b>	23	4	15	23	60	0,18	9	0,017	6
	35	4	15	35	40	0,18			
	47	4	15	47	30	0,18			
	70	4	15	70	20	0,18			
	93	4	15	93	15	0,18			
<b>AS 15 FX</b>	56	4	15	23	60	0,18	13	0,041	12
	86	4	15	35	40	0,18			
	115	4	15	47	30	0,18			
	172	4	15	70	20	0,18			
	228	4	15	93	15	0,18			
<b>AS 20 FX</b>	149	5	* 15 - 40	23	60	0,18	17	0,108	20
	227	5	* 15 - 40	35	40	0,18			
	305	5	* 15 - 30	47	30	0,18			
	453	5	* 15 - 30	70	20	0,18			
	602	5	* 10 - 20	93	15	0,18			
<b>AS 25 FX</b>	538	6	* 20 - 40	28	60	0,37	25	0,320	30
	672	6	* 20 - 40	35	40	0,37			
	902	6	* 20 - 30	47	30	0,37			
	1344	6	* 20 - 30	70	20	0,75			
	1785	6	* 15 - 25	93	15	0,75			

**MOTOR 3 PH - VOLTS 230/400 HZ 50 R.P.M. I400 IP55**

\*= according to hose compound

A = suction pressure in m  
 P = discharge pressure in m  
 I = ratio

di = inn. diam. pump hose mm  
 Qu = litres for revolution  
 Nm = min. start. torque



AVAILABLE IN ATEX CERTIFICATION:  
 EX: I M2 E II 2G E IIB, TX

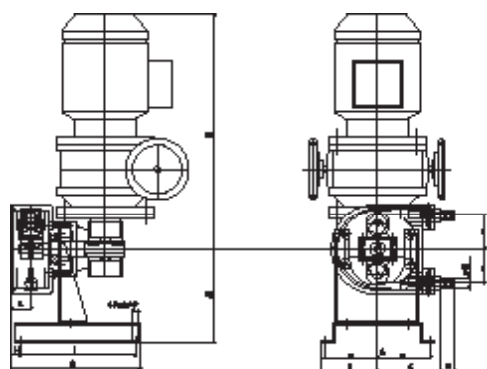

## OVERALL DIMENSIONS

TYPE	A	B	C	D	E	F	G	H	I	L	M	N	øO	Kg.
AS 10 VX	172	92	92	20	15	104	185	12	166	28	137	328	7	12
AS 15 VX	172	92	110	20	20	127	183	12	166	30	137	328	7	13
AS 20 VX	210	112	142	35	25	175	248	18	220	40	184	343	7	22
AS 25 VX	250	146	210	45	32	254	386	81	290	52	228	476	11	45

## TECHNICAL CHARACTERISTICS

TYPE	Q ( L/H)	A	P	RPM	I	KW	di	Qu	Nm
AS 10 VX	3,2 ÷ 15	4	15	3,2 ÷ 15	60	0,22			
	4,7 ÷ 22,5	4	15	4,7 ÷ 22,5	40	0,22			
	6,3 ÷ 30	4	15	6,3 ÷ 30	30	0,22	9	0,017	6
	9,5 ÷ 45	4	15	9,5 ÷ 45	20	0,22			
	19 ÷ 90	4	15	19 ÷ 90	10	0,22			
AS 15 VX	7,8 ÷ 37	4	15	3,2 ÷ 15	60	0,22			
	11,6 ÷ 55	4	15	4,7 ÷ 22,5	40	0,22			
	15,5 ÷ 73,8	4	15	6,3 ÷ 30	30	0,22	13	0,041	12
	23,4 ÷ 110	4	15	9,5 ÷ 45	20	0,22			
	47 ÷ 221	4	15	19 ÷ 90	10	0,22			
AS 20 VX	21 ÷ 97	5	* 15 - 40	3,2 ÷ 15	60	0,22			
	30 ÷ 146	5	* 15 - 40	4,7 ÷ 22,5	40	0,22			
	41 ÷ 194	5	* 15 - 40	6,3 ÷ 30	30	0,22	17	0,108	20
	62 ÷ 291	5	* 15 - 40	9,5 ÷ 45	20	0,22			
	82 ÷ 388	5	* 15 - 40	12,7 ÷ 60	15	0,22			
AS 25 VX	73 ÷ 365	6	* 20 - 40	3,8 ÷ 19	60	0,37			
	90 ÷ 455	6	* 20 - 40	4,7 ÷ 23,7	40	0,37			
	121 ÷ 608	6	* 20 - 35	6,3 ÷ 31,7	30	0,37	25	0,320	30
	182 ÷ 912	6	* 15 - 30	9,5 ÷ 47,5	20	0,37			
	243 ÷ 1280	6	* 15 - 25	12,7 ÷ 66,7	15	0,75			

**MOTOR 3 PH - VOLTS 230/400 HZ 50 R.P.M. I400 IP55**

\* = according to hose compound

A = suction pressure in m  
 P = discharge pressure in m  
 I = ratio

di = inn. diam. pump hose mm  
 Qu = litres for revolution  
 Nm = min. start. torque



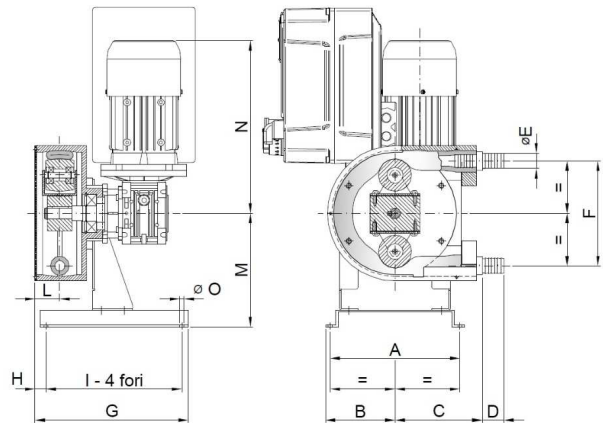

## OVERALL DIMENSIONS

TYPE	A	B	C	D	E	F	G	H	I	L	M	N	øO	Kg.
AS 10 IX	172	92	92	20	15	104	185	12	166	28	137	245	7	9
AS 15 IX	172	92	110	20	20	127	183	12	166	30	137	245	7	10
AS 20 IX	210	112	142	35	25	175	248	18	220	40	184	260	7	18
AS 25 IX	250	146	210	45	32	254	386	81	290	52	228	370	11	40

## TECHNICAL CHARACTERISTICS

TYPE	Q (L/H)	A	P	RPM	I	KW	di	Qu	Nm
AS 10 IX	1,5 ÷ 47	4	15	1,5 ÷ 47	60	0,18	9	0,017	6
	3 ÷ 93	4	15	3 ÷ 93	30	0,18			
	6 ÷ 185	4	10	6 ÷ 185	15	0,18			
AS 15 IX	3,7 ÷ 115	4	15	1,5 ÷ 47	60	0,18	13	0,041	12
	7 ÷ 172	4	15	2,8 ÷ 70	40	0,18			
	15 ÷ 345	4	15	6 ÷ 140	30	0,18			
AS 20 IX	10 ÷ 304	5	* 15 - 40	1,5 ÷ 47	60	0,18	17	0,108	20
	18 ÷ 453	5	* 15 - 40	2,8 ÷ 70	40	0,18			
	20 ÷ 602	5	* 15 - 30	3 ÷ 93	30	0,18			
AS 25 IX	29 ÷ 902	6	* 20 - 40	1,5 ÷ 47	60	0,37	25	0,320	30
	54 ÷ 1344	6	* 20 - 40	2,8 ÷ 70	40	0,55			
	58 ÷ 1785	6	* 15 - 25	3 ÷ 93	30	0,75			

**MOTOR 3 PH - VOLTS 230/400 HZ 50 R.P.M. 1400 IP55**

\*= according to hose compound

### 4-20mA SIGNAL ON DEMAND

A = suction pressure in m  
 P = discharge pressure in m  
 I = ratio

di = inn. diam. pump hose mm  
 Qu = litres for revolution  
 Nm = min. start. torque

## PERFORMANCE CURVES

Portata / Output  
Q (l/min) Q (l/h)

**AS 10**

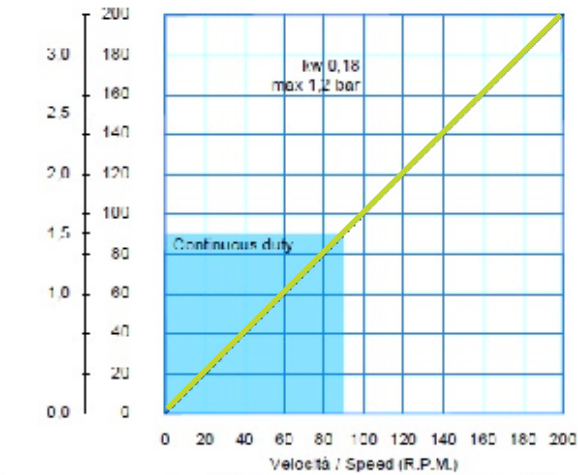

Portata / Output  
Q (l/min) Q (l/h)

**AS 15**

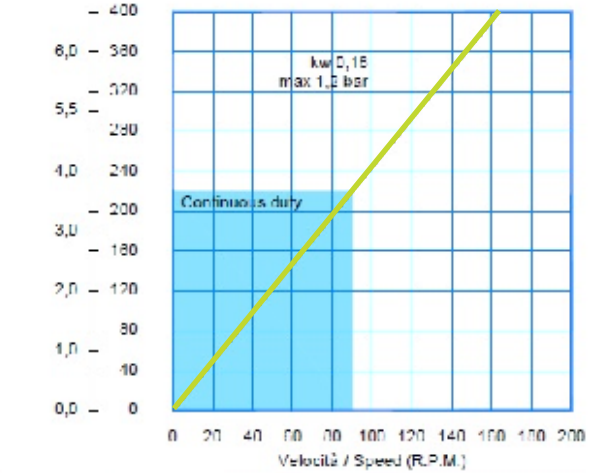

Portata / Output  
Q (l/min) Q (l/h)

**AS 20**

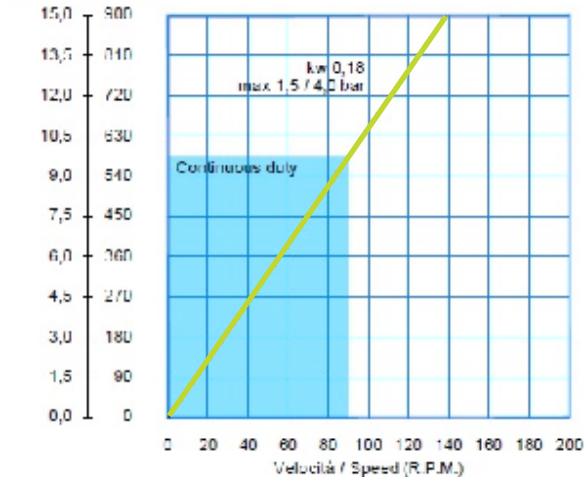

Portata / Output  
Q (l/min) Q (l/h)

**AS 25**

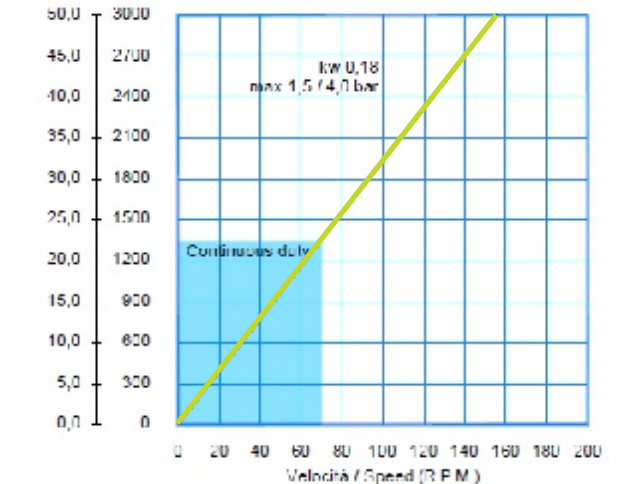

### SPECIAL VERSION



DOUBLE HEAD

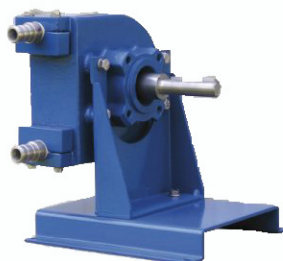

PUMP HEAD

### HOW TO USE THE CURVES

- Flow required indicates pump speed
- Calculated discharge pressure
- Net motor power required
- Fluid temperature
- Calculated discharge pressure
- Maximum recommended pump speed

The operating data here described refer to water or similar peculiarity fluid





# HELIOS ASP

**Peristaltic pumps**  
**Capacity up to about 25000 l/h - delivery head up to 10 bar**  
**Viscosity up to 60000 cps - Achievable suction up to 8 mts**

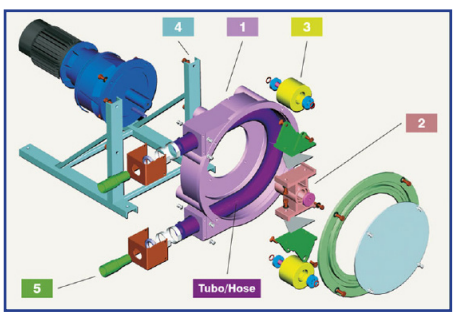

Element	Material
1 Pump casing	aluminium alloy
2 Rotor	aluminium alloy
3 Rollers	aluminium nylatron
4 Base	Iron
5 Hose Connector	AISI 304

**Special couplings:**  
 Hose Connector in AISI 316, PVC, PTFE  
 DIN  
 TRI-CLAMPS  
 ANSI, ISO, UNI, FLANGES

**TECHNICAL FEATURES**

- No mechanical seal or stuffing box
- Robust
- Suitable for aggressive or viscous fluids
- Damage-free continuous dry running
- Outlet pressures up to 10 bar
- Very easy maintenance

**AVAILABLE HOSES MATERIALS**

- NR
- NBR
- EPDM
- NBR Food
- NR Food
- Hypalon
- EPDM Food

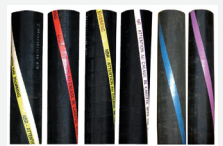

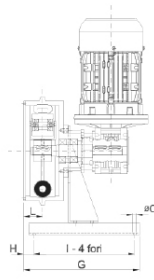
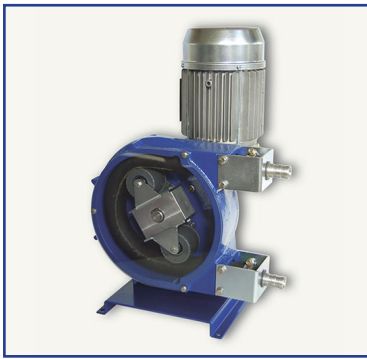

**ASP 10/15**

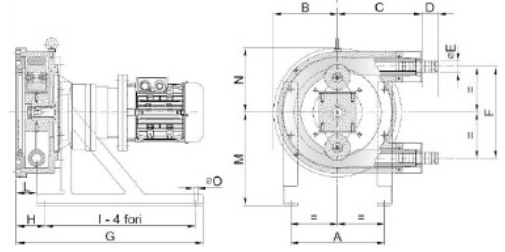
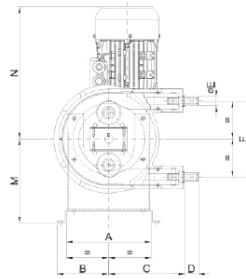

**ASP 25/15 - 25 - 32 - 40 - 50 - 65**

## OVERALL DIMENSIONS

TYPE	A	B	C	D	E	F	G	H	I	L	M	N	øO	Kg.
ASP 10 FX	210	112	166	25	15	167	251	21	220	40	184	260	7	16
ASP 15 FX	210	112	166	30	20	167	251	21	220	40	184	260	7	16
ASP 25/15 FX	250	170	224	25	20	240	495	75	400	52	228	70	11	44
ASP 25 FX	250	170	224	25	32	240	495	75	400	52	228	170	11	44
ASP 32 FX	330	217	230	66	40	314	655	114	520	68	300	217	11	80
ASP 40 FX	420	270	340	70	50	398	735	130	580	74	370	270	14	120
ASP 50 FX	420	330	380	80	65	512	833	158	650	88	440	330	14	160
ASP 65 FX	566	440	510	91	80	672	1107	142	930	106	570	440	17	430

## TECHNICAL CHARACTERISTICS

TYPE	Q ( L/H)	A	P	RPM	I	KW	di	Qu	Nm
ASP 10 FX	47	8	100	23	60	0,18	10	0,034	35
	72	8	80	35	40	0,18			
	96	8	80	47	30	0,37			
	143	8	80	70	20	0,37			
ASP 15 FX	102	8	100	23	60	0,18	15	0,074	35
	155	8	80	35	40	0,18			
	209	8	80	47	30	0,37			
	310	8	80	70	20	0,37			
ASP 25/15 FX	275	8	80	35	40	0,55	15	0,131	40
	354	8	80	45	31,5	0,75			
	440	8	70	56	25	0,75			
	550	8	60	70	20	0,75			
ASP 25 FX	672	8	80	35	40	0,55	25	0,32	40
	864	8	80	45	31,5	0,75			
	1075	8	70	56	25	0,75			
	1344	8	60	70	20	0,75			
ASP 32 FX	1596	8	100	38	37	1,1	32	0,70	75
	1974	8	80	47	30	1,1			
	2436	8	60	58	24	1,1			
	2940	8	40	70	20	1,1			
ASP 40 FX	2040	8	100	25	56	1,5	40	1,36	110
	2938	8	80	36	39	1,5			
	3672	8	60	45	31,5	1,5			
	5712	8	40	70	20	1,5			
ASP 50 FX	4185	8	100	25	56	2,2	50	2,79	200
	6026	8	60	36	39	2,2			
	7533	8	60	45	31,5	3			
	11718	8	40	70	20	3			
ASP 65 FX	8580	8	80	22	63	4	65	6,50	400
	13650	8	60	35	40	5,5			
	15500	8	60	45	31,5	7,5			
	21840	8	50	56	25	7,5			

## MOTOR 3 PH - VOLTS 230/400 HZ 50 R.P.M. 1400 IP55

A = suction pressure in m  
 P = discharge pressure in m  
 I = ratio

\*= according to hose compound  
 di = inn. diam. pump hose mm  
 Qu = litres for revolution  
 Nm = min. start. torque



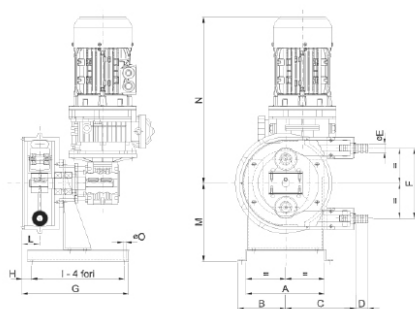

**ASP 10/15**

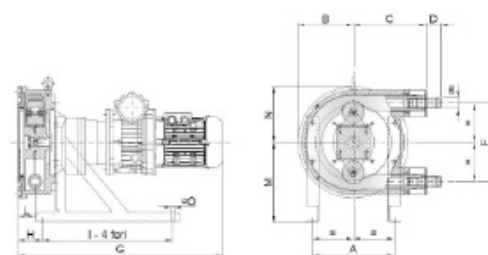

**ASP 25/15 - 25 - 32 - 40 - 50 - 65**

## OVERALL DIMENSIONS

TYPE	A	B	C	D	E	F	G	H	I	L	M	N	øO	Kg.
<b>ASP 10 VX</b>	210	112	166	25	15	167	251	21	220	40	184	345	7	20
<b>ASP 15 VX</b>	210	112	166	30	20	167	251	21	220	40	184	345	7	20
<b>ASP 25/15 VX</b>	250	170	224	45	20	240	640	75	400	52	228	170	11	50
<b>ASP 25 VX</b>	250	170	224	45	32	240	640	75	400	52	228	170	11	50
<b>ASP 32 VX</b>	330	217	290	66	40	314	735	114	520	68	300	217	11	90
<b>ASP 40 VX</b>	420	270	340	70	50	398	884	130	580	74	370	270	14	120
<b>ASP 50 VX</b>	420	330	380	80	65	512	1017	158	650	88	440	330	14	180
<b>ASP 65 VX</b>	566	440	510	91	80	672	1385	142	930	106	570	440	18	430

## TECHNICAL CHARACTERISTICS

TYPE	Q ( L/H)	A	P	RPM	I	KW	di	Qu	Nm
<b>ASP 10 VX</b>	6,5÷30,6	8	100/80	3,2÷15	60	0,22	10	0,034	35
	9,6÷46	8	100/70	4,7÷22,5	40	0,22			
	15,5÷77,5	8	100/60	7,6÷38	25	0,37			
	26÷129	8	100/50	12,7÷63,3	15	0,37			
<b>ASP 15 VX</b>	14,2÷66,6	8	100/80	3,2÷15	60	0,22	15	0,074	35
	21÷100	8	100/70	4,7÷22,5	40	0,22			
	34÷168,7	8	100/60	7,6÷38	25	0,37			
	56,4÷281	8	100/50	12,7÷63,3	15	0,37			
<b>ASP 25/15 VX</b>	37÷196,5	8	100/60	4,7÷25	40	0,55	15	0,131	40
	60÷314,4	8	100/70	7,6÷40	25	0,75			
	94,3÷487,3	8	100/50	12÷62	16	0,75			
	118÷629	8	100/40	15÷80	12,5	0,75			
<b>ASP 25 VX</b>	90÷480	8	100/60	4,7÷25	40	0,55	25	0,32	40
	146÷768	8	100/60	7,6÷40	25	0,75			
	230÷1190	8	100/50	12÷62	16	0,75			
	288÷1536	8	100/40	15÷80	12,5	0,75			
<b>ASP 32 VX</b>	210÷1134	8	100/60	5÷27	37	1,1	32	0,70	75
	319÷1680	8	100/60	7,6÷40	25	1,1			
	504÷2604	8	100/50	12÷62	16	1,1			
	630÷3360	8	100/40	15÷80	12,5	1,1			
<b>ASP 40 VX</b>	342÷1811	8	100/60	4,2÷22,2	45	1,5	40	1,36	110
	489÷2611	8	100/60	6÷32	31,5	1,5			
	775÷4080	8	100/50	9,5÷50	20	2,2			
	979÷5059	8	100/40	12÷62	16	2,2			
<b>ASP 50 VX</b>	703÷3716	8	100/60	4,2÷22,2	45	2,2	50	2,79	200
	1004÷5356	8	100/60	6÷32	31,5	2,2			
	1590÷8370	8	100/50	9,5÷50	20	3			
	2008÷10378	8	100/40	12÷62	16	3			
<b>ASP 65 VX</b>	1638÷8658	8	100/60	4,2÷22,2	45	4	65	6,50	400
	2340÷12480	8	100/60	6÷32	31,5	5,5			
	2964÷15600	8	100/50	7,6÷40	25	7,5			
	3705÷19500	8	100/40	9,5÷50	20	7,5			

## MOTOR 3 PH - VOLTS 230/400 HZ 50 R.P.M. I400 IP55

A = suction pressure in m  
P = discharge pressure in m  
I = ratio

\*= according to hose compound  
di = inn. diam. pump hose mm  
Qu = litres for revolution  
Nm = min. start. torque

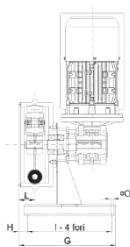

**ASP 10/15**

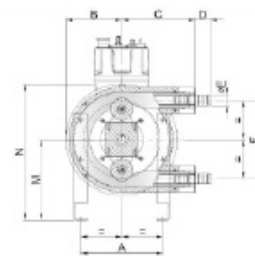
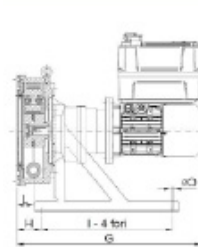
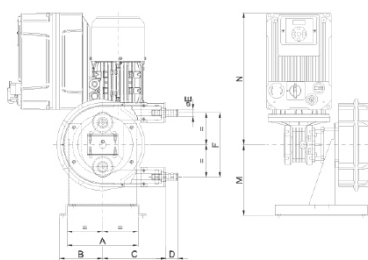

**ASP 25/15 - 25 - 32 - 40 - 50 - 65**

## OVERALL DIMENSIONS

TYPE	A	B	C	D	E	F	G	H	I	L	M	N	øO	Kg.
<b>ASP 10 IX</b>	210	112	166	25	15	167	251	21	220	40	184	334	7	25
<b>ASP 15 IX</b>	210	112	166	30	20	167	251	21	220	40	184	334	7	25
<b>ASP 25/15 IX</b>	250	170	224	25	20	240	550	75	400	52	228	398	11	54
<b>ASP 25 IX</b>	250	170	224	25	32	240	550	75	400	52	228	398	11	54
<b>ASP 32 IX</b>	330	217	230	66	40	314	654	114	520	68	300	517	11	90
<b>ASP 40 IX</b>	420	270	340	70	50	398	735	130	580	74	370	640	14	130
<b>ASP 50 IX</b>	420	330	380	80	65	512	833	158	650	88	440	770	14	170
<b>ASP 65 IX</b>	566	440	510	91	80	672	1107	142	930	106	570	1010	18	430

## TECHNICAL CHARACTERISTICS

TYPE	Q ( L/H)	A	P	RPM	I	KW	di	Qu	Nm
<b>ASP 10 IX</b>	9÷65	8	100/80	4,5÷32	60	0,25	10	0,034	35
	19÷130	8	100/60	9,3÷65	40	0,37			
	28,5÷200	8	100/50	14÷98	20	0,37			
<b>ASP 15 IX</b>	20÷142	8	100/80	4,5÷32	60	0,25	15	0,074	35
	41,3÷289	8	100/60	9,3÷65	30	0,37			
	62÷435	8	100/50	14÷98	20	0,37			
<b>ASP 25/15 IX</b>	55÷385	8	100/80	7÷49	40	0,75	15	0,131	40
	71÷495	8	100/60	9÷63	31,5	0,75			
	110÷870	8	100/50	14÷98	20	0,75			
<b>ASP 25 IX</b>	134÷940	8	100/80	7÷49	40	0,75	25	0,32	40
	173÷1210	8	100/60	9÷63	31,5	0,75			
	268÷1880	8	100/50	14÷98	20	0,75			
<b>ASP 32 IX</b>	294÷2058	8	100/80	7÷49	46	1,5	32	0,70	75
	390÷2730	8	100/50	9,3÷65	30	1,5			
	588÷4116	8	100/40	14÷98	20	1,5			
<b>ASP 40 IX</b>	408÷2856	8	100/80	5÷35	56	1,5	40	1,36	110
	734÷5140	8	100/50	9÷63	31,5	2,2			
	938÷6528	8	100/40	11,5÷80	24,5	2,2			
<b>ASP 50 IX</b>	837÷5860	8	100/80	5÷35	56	2,2	50	2,79	200
	1507 ÷10546	8	100/50	9÷63	31,5	3			
	1925÷13395	8	100/40	11,5÷80	24,5	4			
<b>ASP 65 IX</b>	1720÷12090	8	100/80	4,4÷31	63	7,5	65	6,50	400
	2730÷19110	8	100/50	7÷49	40	7,5			
	3510÷24570	8	100/40	9÷63	31,5	7,5			

**MOTOR 3 PH - VOLTS 230/400 HZ 50 R.P.M. 1400 IP55**

\*= according to hose compound

### 4-20mA SIGNAL ON DEMAND

A = suction pressure in m  
 P = discharge pressure in m  
 I = ratio

di = inn. diam. pump hose mm  
 Qu = litres for revolution  
 Nm = min. start. torque

## PERFORMANCE CURVES

ASP 10

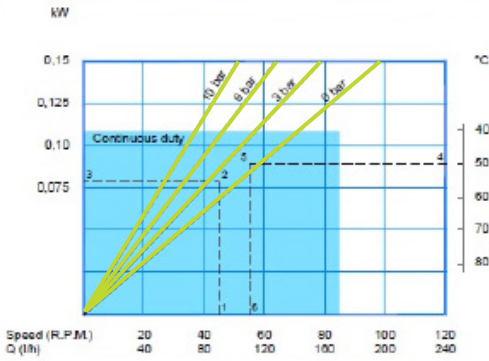

ASP 15

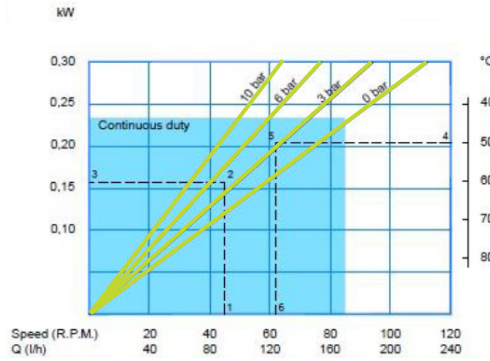

ASP 25/15

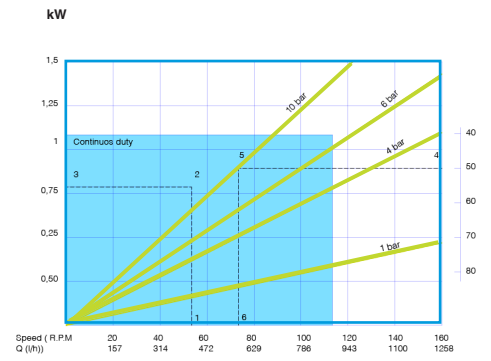

ASP 25

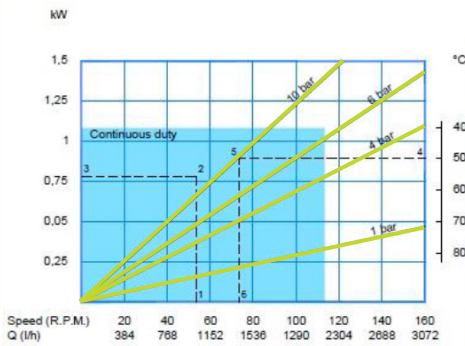

ASP 32

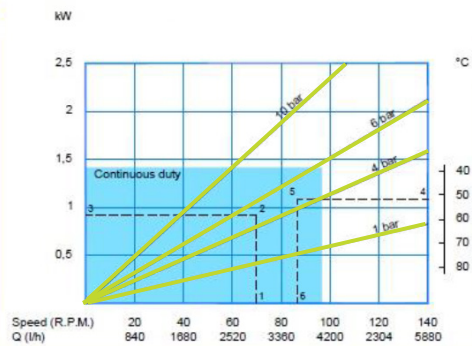

ASP 40

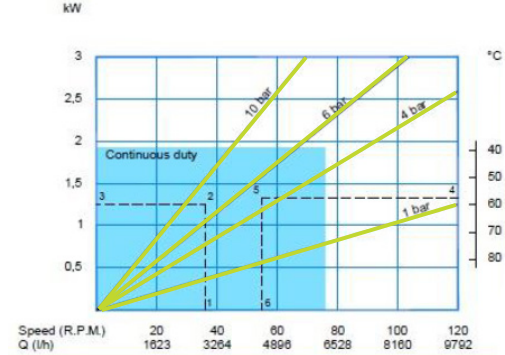

ASP 50

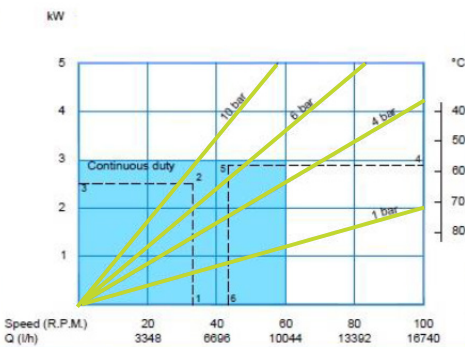

ASP 65

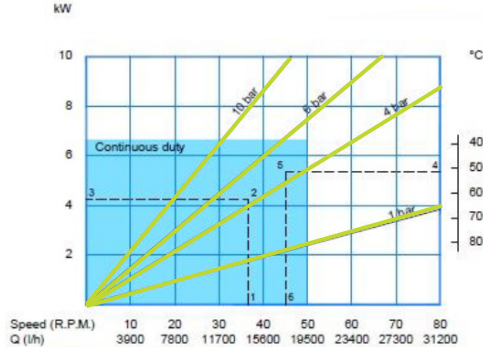

### HOW TO USE THE CURVES

- Flow required indicates pump speed
  - Calculated discharge pressure
  - Net motor power required
  - Fluid temperature
  - Calculated discharge pressure
  - Maximum recommended pump speed
- The operating data here described refer to water or similar peculiarity fluid

### SPECIAL VERSION



DOUBLE HEAD



PUMP HEAD



TROLLEY

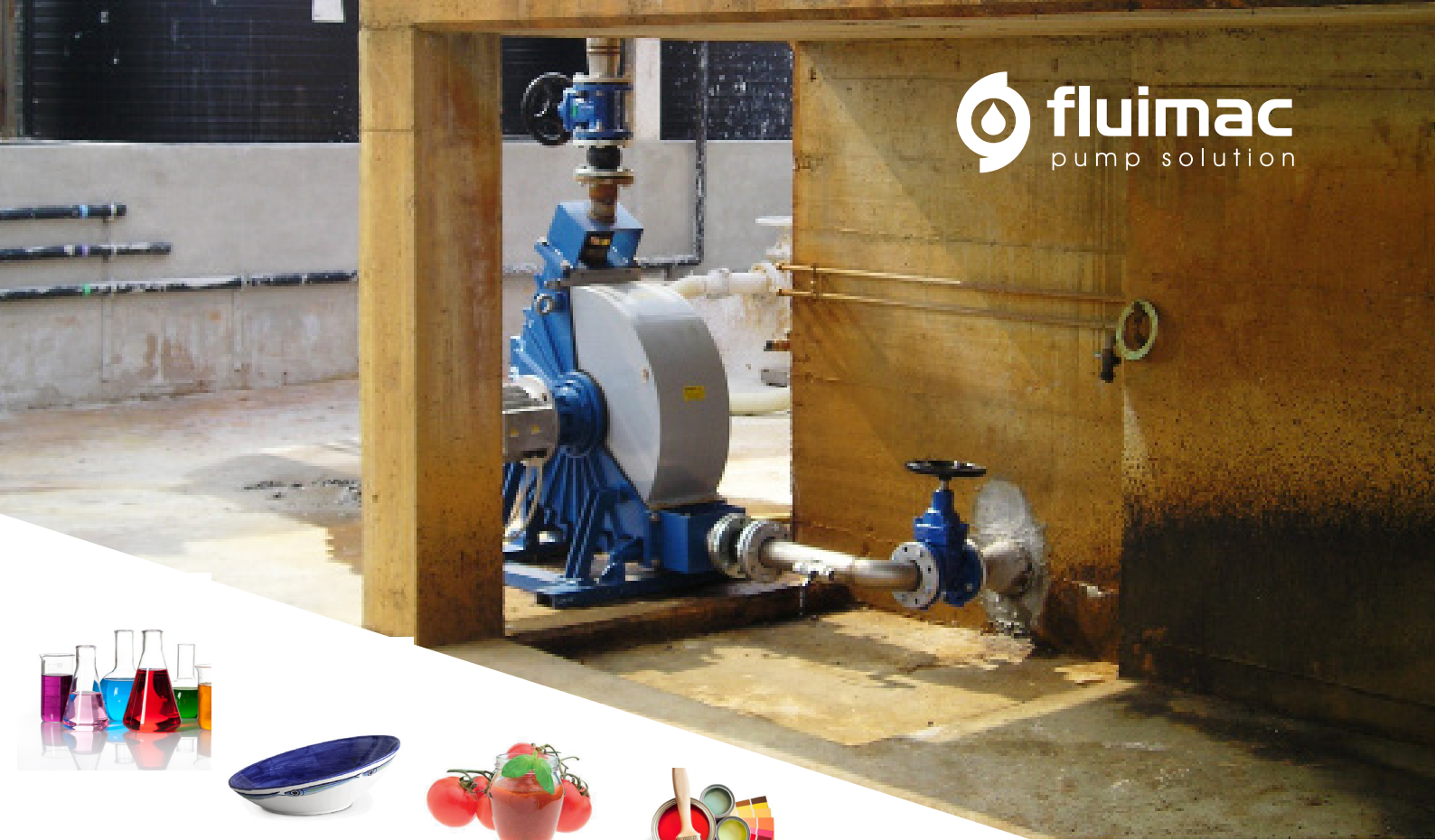

# HELIOS ATR

Peristaltic pumps

Capacity up to about 64000 l/h - delivery head up to 8 bar

Viscosity up to 60000 cps - Achievable suction up to 8 mts

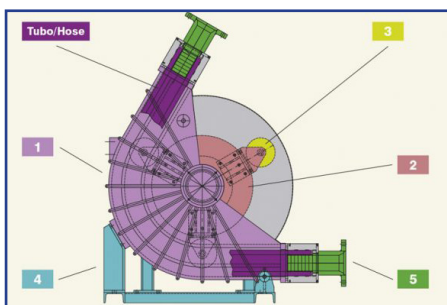

## Element

- 1 Pump casing
- 2 Rotor
- 3 Rollers
- 4 Base
- 5 Flange ISO

## Material

- Cast Iron
- Iron
- aluminium nylatron
- Iron
- AISI 304

## Special couplings:

- DIN
- TRI-CLAMPS
- ANSI, ISO, UNI, FLANGES

## TECHNICAL FEATURES

- No mechanical seal or stuffing box
- Robust
- Suitable for aggressive or viscous fluids
- Damage-free continuous dry running
- Outlet pressures up to 8 bar
- Very easy maintenance
- Big Performance

## AVAILABLE HOSES MATERIALS

- NR
- NBR
- EPDM
- NR Food
- Hypalon

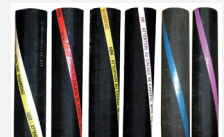

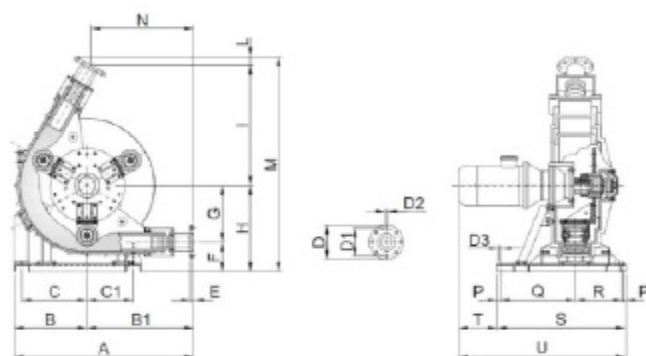

## ATR 80 FX/TD

### OVERALL DIMENSIONS

A	B	B1	C	C1	D	D1	D2	D3	E	F	G	H	I	L	M	N	O	P	Q	R	S	T	U
1148	467	681	417	295	220	180	16	18	22	189	365	554	772	55	1391	657	O	20	480	300	820	245	1065

### TECHNICAL CHARACTERISTICS

Q(L/H)	A	P	RPM	Kw	di	Qu	Nm	Kg
12160	8	50 (80)	22,3	5,5 (7,5)				
18874	8	30 (50)	34,6	5,5 (9)	80	9,1	1200	390
21915	8	25 (45)	40,1	5,5 (9)				
26422	8	20 (40)	48,4	7,5 (11)				

## ATR 280 FX/TD

### OVERALL DIMENSIONS

A	B	B1	C	C1	D	D1	D2	D3	E	F	G	H	I	L	M	N	O	P	Q	R	S	T	U
1148	467	681	417	295	220	180	16	18	22	189	365	554	772	55	1391	657	119	20	550	370	960	294	1254

### TECHNICAL CHARACTERISTICS

Q(L/H)	A	P	RPM	Kw	di	Qu	Nm	Kg
24321	8	50 (80)	22,2	7,5 (11)				
37748	8	30 (50)	34,6	11 (15)	80	18,2	2000	515
43830	8	25 (45)	40,1	11 (15)				
52845	8	20 (40)	48,4	11 (15)				

### MOTOR 3 PH - VOLTS 230/400 HZ 50 R.P.M. 1400 IP55

- \* = according to hose compound
- A = suction pressure in m
- P = discharge pressure in m

- di = inn. diam. pump hose mm
- Qu = litres for revolution
- Nm = min. start. torque

**Ex** AVAILABLE IN ATEX CERTIFICATION:  
EX: I M2 E II 2G E IIB, TX



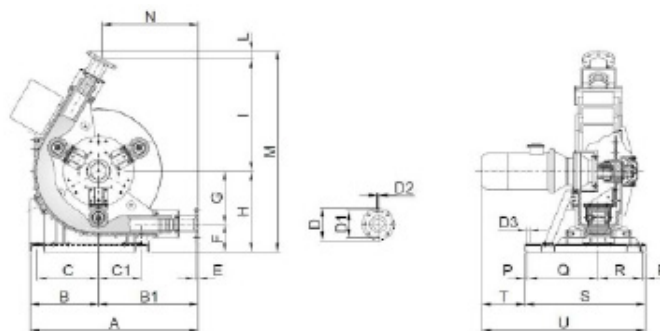

## ATR 80 IX/TD

### OVERALL DIMENSIONS

A	B	B1	C	C1	D	D1	D2	D3	E	F	G	H	I	L	M	N	O	P	Q	R	S	T	U
1148	467	681	417	295	220	180	16	18	22	189	365	554	772	55	1381	657	O	20	480	300	820	245	1065

### TECHNICAL CHARACTERISTICS

Q(L/H)	A	P	RPM	Kw	hz	di	Qu	Nm	Kg
2432 ÷ 14592	8	50 (80)	4,5 ÷ 26,7	5,5 (7,5)					
3775 ÷ 22649	8	30 (50)	6,9 ÷ 41,5	5,5 (9)	10 ÷ 60	80	9,1	1200	440
4383 ÷ 26298	8	25 (45)	8,0 ÷ 48,2	7,5 (11)					
5284 ÷ 31707	8	20 (40)	9,7 ÷ 58,1	7,5 (11)					

## ATR 280 IX/TD

### OVERALL DIMENSIONS

A	B	B1	C	C1	D	D1	D2	D3	E	F	G	H	I	L	M	N	O	P	Q	R	S	T	U
1148	467	681	417	295	220	180	16	18	22	189	365	554	772	55	1381	657	119	20	550	370	960	294	1254

### TECHNICAL CHARACTERISTICS

Q(L/H)	A	P	RPM	Kw	hz	di	Qu	Nm	Kg
4864 ÷ 29185	8	50 (80)	4,5 ÷ 26,7	11 (15)					
7550 ÷ 45298	8	30 (50)	6,9 ÷ 41,5	11 (15)	10 ÷ 60	80	18,2	2000	580
8766 ÷ 52596	8	25 (45)	8,0 ÷ 48,2	11 (15)					
10569 ÷ 63414	8	20 (40)	9,7 ÷ 58,1	11 (15)					

### MOTOR 3 PH - VOLTS 230/400 HZ 50 R.P.M. I400 IP55

#### 4-20mA SIGNAL ON DEMAND

\* = according to hose compound  
 A = suction pressure in m  
 P = discharge pressure in m

di = inn. diam. pump hose mm  
 Qu = litres for revolution  
 Nm = min. start. torque

## PERFORMANCE CURVES

## SPECIAL VERSION

Portata / Output

**ATR 80**

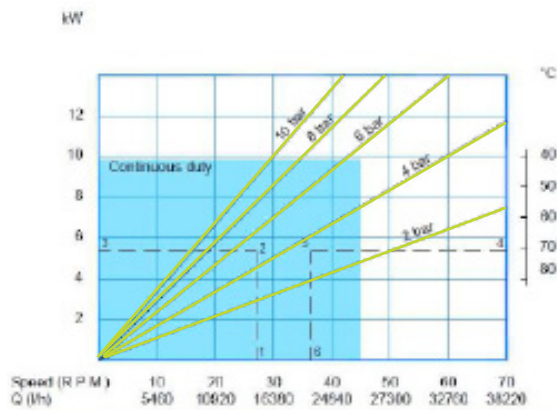

**ATR 80/280 TC**  
BELT TRANSMISSION

Portata / Output

**ATR 280**

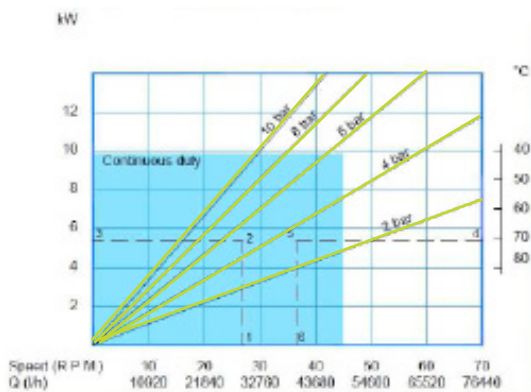

PUMP HEAD

### HOW TO USE THE CURVES

- Flow required indicates pump speed
- Calculated discharge pressure
- Net motor power required
- Fluid temperature
- Calculated discharge pressure
- Maximum recommended pump speed

The operating data here described refer to water or similar peculiarity fluid



TROLLEY

# fluimac®

pump solution



**FLUIMAC S.r.l.**

Via Ticino 2 / 4  
21043, Castiglione Olona (VA) - Italy  
Tel.:+39 0331 866688  
Fax:+39 0331 864870

[www.fluimac.com](http://www.fluimac.com)  
[info@fluimac.com](mailto:info@fluimac.com)

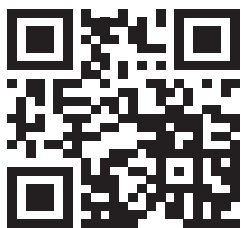

**AUTHORIZED PARTNER:**

*Made in  
Italy*

